

USER MANUAL

# D-FORCE 51

4CH FHD HDR DASH CAM



For truck, Specialty vehicles / Caravan / Bus & Etc.



|         |    |                                       |    |
|---------|----|---------------------------------------|----|
| CONTENT | 01 | <b>INTRODUCTION</b>                   |    |
|         |    | SAFETY INSTRUCTIONS .....             | 02 |
|         |    | USE WITH SD MEMORY CARD .....         | 03 |
|         |    | FEATURES .....                        | 04 |
|         |    | COMPONENTS .....                      | 05 |
|         |    | DIAGRAM .....                         | 06 |
|         |    | SPECIFICATIONS .....                  | 08 |
|         |    | INSTALLATION .....                    | 09 |
|         |    | INSTALLATION DIAGRAM .....            | 13 |
|         | 02 | <b>FUNCTION</b>                       |    |
|         |    | HOW TO USE FEATURES .....             | 16 |
|         |    | MEMORY CARD VIDEO FOLDER .....        | 56 |
|         | 03 | <b>PC VIEWER</b>                      |    |
|         |    | PC VIEWER INSTALLATION (WINDOW) ..... | 58 |
|         |    | PC VIEWER INSTALLATION (MAC) .....    | 63 |
|         | 04 | <b>APPLICATION</b>                    |    |
|         |    | BEFORE WI-FI CONNECTION .....         | 66 |
|         |    | CONNECTION WITH SMART PHONE .....     | 67 |
|         | 05 | <b>withCLOUD</b>                      |    |
|         |    | USING withCLOUD .....                 | 74 |
|         |    | HOW TO REGISTER 'withCLOUD' .....     | 75 |
|         |    | withCLOUD functions .....             | 79 |

© 2024 GNET SYSTEM CO.,LTD. or its subsidiaries All rights reserved. Under the copyright laws, this manual may not be copied, in whole or in part, without the written consent of GNET SYSTEM CO.,LTD.

GNET SYSTEM CO.,LTD reserves the right to change or improve its products and to make changes in the content of this manual without obligation to notify any person or organization of such changes or improvements.

Visit [www.gnetsystem.com](http://www.gnetsystem.com) for current updates and supplemental information concerning the use of this product. GNET® and the GNET logo, are trademarks of GNET SYSTEM CO.,LTD.

or its subsidiaries, registered in South Korea and other countries. GNET D-FORCE S1™, are trademarks of GNET SYSTEM CO.,LTD. or its subsidiaries. These trademarks may not be used without the express permission of GNET. microSD® and the microSD logo are trademarks of SD-3C, LLC. Wi-Fi® is a registered mark of Wi-Fi Alliance Corporation.

---

- **Do not expose the unit to open electrical circuits.**

- This may cause product damage, fire, or electrical shock.

- **Avoid use with excessive vehicle window tints or special auto glass.**

- Images may be blurry or distorted and may cause interference with the reception rate of the GPS.

- **Do not modify or dismantle the device/accessories.**

- We are not responsible for any damage to the device or vehicle if caused by the user.

- **Never operate the device or adjust settings while driving.**

- If needing to adjust settings, park your vehicle safely before doing so.

- **Do not use liquids or chemicals to clean the product or accessories.**

- This may cause product damage, fire, or electrical shock.

- **Use a non-scratch lens cloth to clean the product and accessories.**

- Routinely clean camera lens for best results.

- **Avoid high temperature or high humidity environments for normal operation of the product.**

- D-FORCE S1 is designed to cease recording if the temperature rises beyond approx. 70°C and starts

- **operating again once it goes down below 60°C. This is part of the safety features to protect the internal components and will maintain the device longer. Check the operation of the rear camera(s) periodically before driving.**

- Only the front camera will be captured in the event of a malfunction or defect.

- **Check the operation of both camera(s) regularly.**

- Check the videos in PC Viewer or mobile App frequently and see if the dashcam works as per manual. There are various technical constraints and limitations which may disable the recording in the dashcam.

- The SD memory card has a limited life cycle and will gradually degrade overtime with constant writing and deleting of data. Therefore, it is necessary to replace the SD memory card once it has reached its lifecycle.
- To prevent incompatibility problems, use a genuine GNET Memory card. The GNET memory cards are specifically designed to operate with GNET dashcams and are covered under our warranty program. Other memory cards are not covered under our warranty.
- If you wish to save certain footage, it is advised to remove the memory card from the device and save the data to a computer immediately. When the memory card is full and overwritten, the data cannot be retrieved.
- Ensure to remove the memory card only after the recording LED is off. If removed too early, video data could be lost or corrupted. This can also shorten the card's lifespan.
- Do not swap memory cards between other products. Data may be erased and lost if the memory card is automatically formatted.
- We recommend formatting the memory card more than once a month for maintenance. It is recommended that you format or check the memory card through a SD formatter program via PC Viewer or GNET App.
  - Please check your Micro SD memory card's condition after downloading the SD Formatter program through <http://www.sdcard.org>.
- When a new or used memory card is inserted into the device for the first time, the system will go into standby mode for 3 to 5 minutes. Do not attempt to remove the memory card during standby mode or when the device is formatting the card.



**Waterproof & dustproof**  
(External camera)



**Automatic SD**  
memory card  
recovery function



**ADAS**  
(Advanced system for  
safe drive)



**H.265 CODEC**



**Night vision**



**JDR File system: Automatic**  
memory card recovery  
function & format



**High sensitive**  
external GPS



**SONY STARVIS**  
Image Sensor



**GNET Wi-Fi App**



**Safe recording data store**  
even if power is off



**Built-in voice guide**  
and high quality  
microphone



**Parking Mode**



**LOW BATTERY**  
PROTECTION



**CLOUD SYSTEM**



**12.3" wide touch**  
screen



**Time lapses**

### Basic components



Divider, Front camera,  
2sets\* side truck cameras,  
rear camera



12.3" wide screen



3 wired Hardware  
power cable



Micro SD  
memory card



Wi-Fi  
dongle



Quick  
manual



Cable for  
a turn signal



Cable for  
rear camera  
(20m)



Cable for  
front camera  
(3m)



Cable for  
sidecamera  
(5m\*2ea)



Cable for  
LCD monitor



Bracket  
for LCD  
monitor



Cradle  
for LCD  
monitor



Bracket



Bracket  
sponge



External GPS



screw,  
wrench

### Optional components (Sold seperately)



AV-OUT Cable



OBD scanner



Cigarette lighter  
power cable

! Please check all parts are included

- ※ The size and appearance of the components depicted above may be different from the real components.
- ※ Specifications and components may be changed without notice for quality assurance.
- ※ We highly recommend using the GNET's genuine memory card provided due to system compatibility.

## Divider

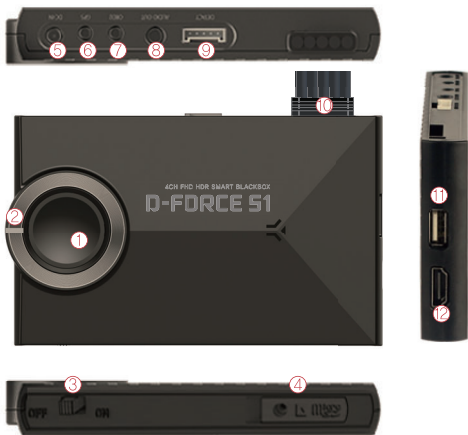

- ① Wi-Fi connection button
- ② REC LED
- ③ Power button
- ④ Micro SD cover
- ⑤ Power connector port (DC-IN)
- ⑥ OBD2 connector port
- ⑦ GPS connector port
- ⑧ AV-OUT connector port
- ⑨ Turn signal connector cable
- ⑩ Connection cable (Side, Front, Rear, External storage)
- ⑪ USB Wi-Fi port
- ⑫ HDMI connector port

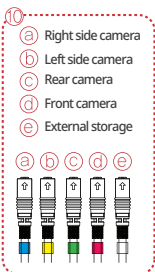

## LCD Monitor



- ① Power button
- ③ Volume (+)
- ⑤ USB C type cable connection port
- ② Lightness (3 levels adjustable)
- ④ Volume (-)

## Front camera



- ⑥ Front camera lens

## Side/ Rear camera



- ⑦ Side/ Rear camera lens
- ⑧ IR lens
- ⑨ Illumination sensor



|                                     |  |
|-------------------------------------|--|
| Channel                             | 4Channels(Front, Rear, Left and Right camera)  |
| Image sensor                        | FHD SONY STARVIS(FHD for all cameras)  |
| Audio input                         | Built-in Microphone  |
| Video Compression                   | H.265  |
| Audio Compression                   | ADPCM  |
| Resolution                          | Front, Rear, Right, Left 1080P (FHD 1920 X 1080P)  |
| Frame Rate                          | All cameras : Max. 30 FPS  |
| Wi-Fi button                        | Standby mode for registration on Smartphone  |
| G-Sensor                            | Event recording by External Shock  |
| Speaker                             | Operation Status alarm / Voice guidance  |
| External GPS                        | Synched with Google map, Keep track of location and Speed  |
| Angle Of View                       | Front: 140°, Rear: 140°, Right Side: 140°, Left Side: 140°   |
| Viewer                              | Win7, Win8, Win10(32Bit~64Bit) / MAC OS X supported  |
| Power                               | DC 12V – 24V   |
| Allowable current of providing fuse | 3A   |
| Operation Temperature               | Operation Temperature : -10°C ~ 70°C<br>Storage temperature : -20°C ~ 80°C   |
| Humidity                            | 10~95%   |
| Waterproof/dustproof                | External truck IR camera: IP69K  |
| Dimension (WxHxD, mm)               | LCD Monitor:308,2x131,5x29,4MM 12,3Inch<br>Divider:120x74,8x18MM / Front camera:59,5x39,8x31,2MM<br>Left, Right and Rear camera:65x49x59,5MM |

## Power Supply

- 1 3rd party electronics should only be installed by professional technicians. The following example is for guidance only. Refer to your car Owner's Manual for specific details. We are not responsible for any malfunctions, accidents, damage to vehicles or products that occur due to installation at a non-professional installation shop.

The internal fuse box of a car varies depending on the car model, so it is recommended that you refer to the car manual and have the 3 wired hardwire power cable connection installed by the dealer where you purchased the product or an automobile-related company.

- 1 Open the fuse box inside the car (under the driver's seat, etc.) and use an electric tester to find the fuse to be installed.

(VCC) wire : it is connected to the fuse that a current flows after car's engine turns off

(ACC) wire : it is connected to the fuse that a current does not flow after car's engine turns off

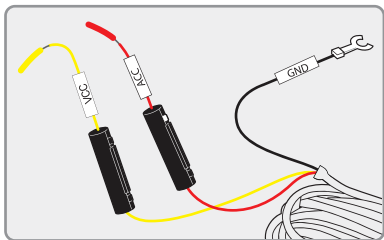

- 2 After connecting the VCC [B+] and the [ACC] onto the vehicle fuses, place them into the Fuse box.

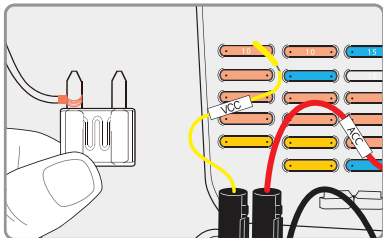

- 3 [GND](Black line) : Connect the black cable (GND) to a ground plate. See car Manual for details. Once connected, the dashcam will turn on with the key in the ACC position. Parking mode will start once the key is turned off. Activating the voltage cut off. The camera will shut down when the car battery voltage drops below the selected cut off voltage.

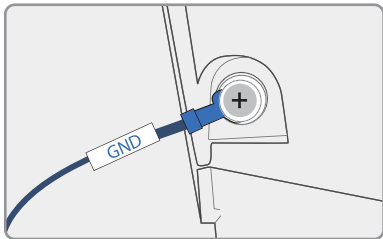

- 4 Connect the power cable to confirm the operation of product. And organize cables to finish installation work.

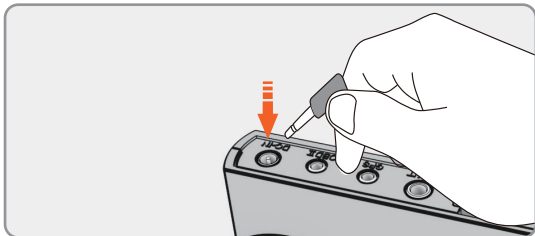

## Inserting the Memory Card

Make sure that the printed side of the SD memory card is facing up when inserting into the card slot as per diagram.

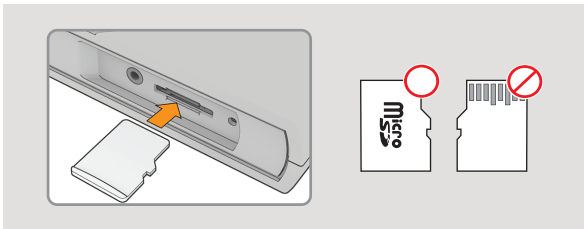

- Push the Micro SD memory card into the memory card slot until you hear a 'click' sound
- When using the new SD memory card or formatting the SD memory card, it takes approx. 3-5 minutes to boot and start normal recording to make file systems and check the memory card
- Recording starts with voice guidance saying "Start recording".

## Diagram of divider ports

\* Please install cables after checking VCC, ACC and GND cables' color

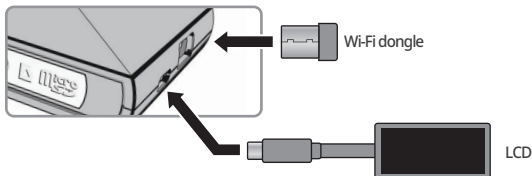
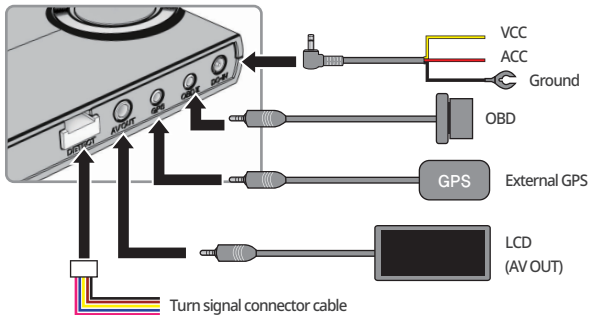

## Diagram of camera connection cable

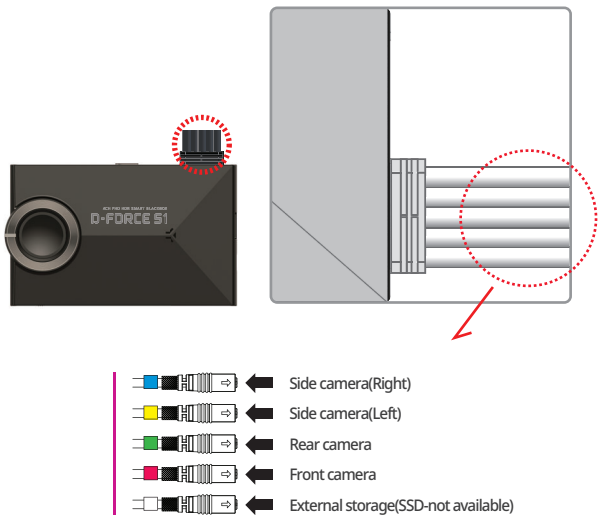

※ Side cameras are recorded with the function of mirrored mode.

### Interlocking cable with left / right turn signal and reversing light

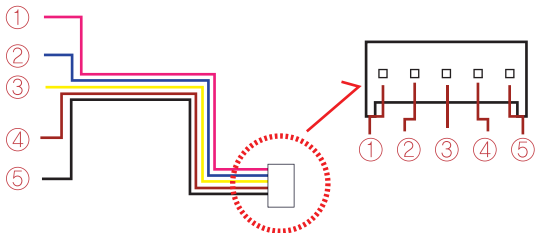

|                       |                          |
|-----------------------|--------------------------|
| ① Reverse(Pink)       | GPS MAP                  |
| ② Right(Blue)         | Right signal             |
| ③ Left(Yellow)        | Left signal              |
| ④ Front and Rear(Red) | Front & rear signal lamp |
| ⑤ GND(Black)          | Grounding                |



### How to connect with LCD monitor

Connect the LCD monitor with the divider by an USB C type cable

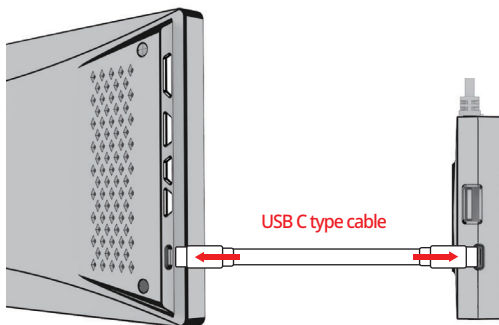

### When connecting to withCLOUD

Press the Wi-Fi button, you will hear a voice "CLOUD is connected" or "CLOUD is disconnected" depending on the connection status.

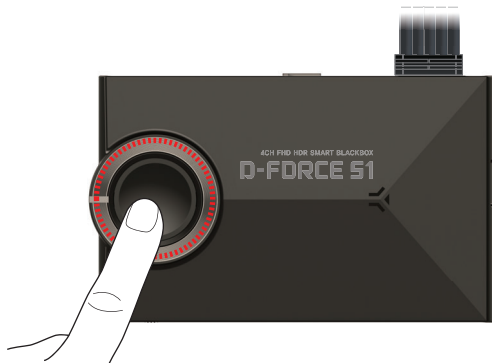

## Power ON/OFF

Shut down and restart the system using the power slide button at the bottom of the product.

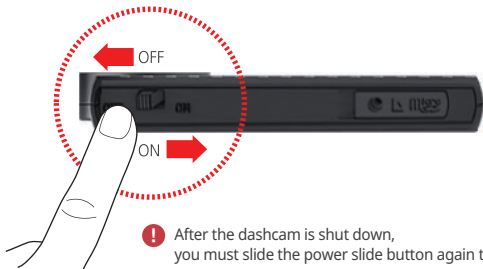

## Real time video

When you operate the vehicle's turn signal (left/right/emergency) while the vehicle's engine is on, real-time video appears on the GNET 12.3" LCD monitor connected to AV OUT.

! The function is available on only a vehicle with the GNET 12.3" LCD monitor connected to AV OUT

## Real-time video transition

! The product's real-time screen is an auxiliary tool that helps drivers drive safely by showing blind spots while driving and parking. Please note that in the event of a vehicle accident, the driver is responsible.

### ※ Right turn signal light "ON"

When you turn on the right turn signal, the real-time video on the right appears on the display screen.



**※ Left turn signal light “ON”**

When you turn on the left turn signal, the real-time image on the left appears on the display screen.

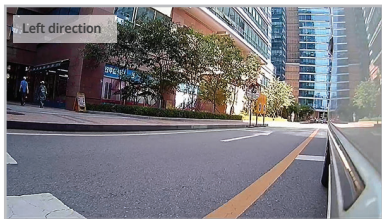
**※ Emergency direction indicator lights “ON”**

When you turn on the vehicle's emergency turn signal, four divided real-time images in the front/rear and left/right directions are displayed on the display screen.

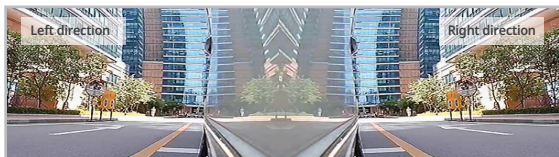

## How to change the angle of the external camera

It can be adjusted to the desired angle up, down, left, and right, allowing video recording in the correct direction.

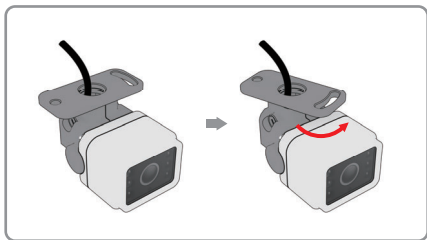

Left and right angle adjustment

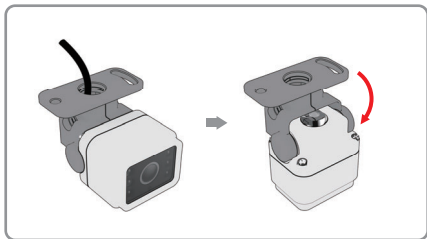

Up and down angle adjustment

## ADAS FUNCTION

ADAS function can be set on GNET Application.

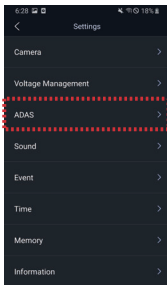

① ADAS ON/OFF :  
Turn on/off the ADAS as touching ADAS ON/OFF button.

② LDWS(Lane Departure Warning System) :  
When the car leaves the lane, detection alarm will be ringing However, the LDWS will only work if it is above the set speed.

③ FVSA (Front Vehicle Start Alarm) :  
Alarm will activate when the stopped front vehicle departs away over 2 meters

④ FCWS (Forward Collision Warning System) :  
When the driver approaches very close to front vehicle, the alarm will be ringing

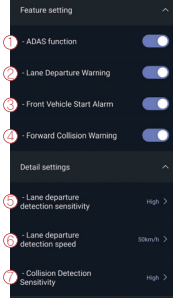

⑤ Lane departure detection sensitivity :  
Set the detection sensitivity as 3 steps  
( Lower, Medium, Higher )

⑥ Lane departure detection speed :  
Set the lowest lane detection speed  
(50km/h, 60km/h, 70km/h)

⑦ Collision detection sensitivity :  
Set the collision detection sensitivity as 3 steps  
( Low, Basic, High )

## • ADAS Lane correction - Android

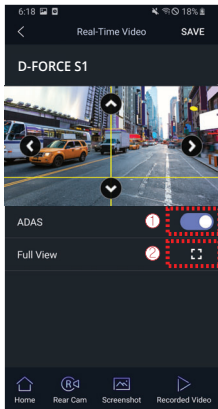

❗ To improve the ADAS recognition rate, it is recommended to adjust the dash camera position by matching the end of the vehicle bonnet line on condition that "the lane correction button" is turned on in the real time screen.

- ① Guideline on / off
- ② Full screen (landscape)



- ① Up direction
- ② Left direction
- ③ Right direction
- ④ Downward direction
- ⑤ Exit (backward)
- ⑥ Save
- ⑦ Guideline on / off
- ⑧ Screen zoom out



## LCD Monitor

When the product is turned on, the video below appears on the LCD screen along with the voice saying "Start recording".



|                          |   |                        |          |
|--------------------------|---|------------------------|----------|
| ① Menu                   | Manual recording  | Dashcam setting        | System   |
| ② Voice recording        | ON / OFF  | ④ ADAS                 | ON / OFF |
| ③ Safe driving assistant | ON / OFF  | ⑤ Screen Saver (Clock) | ON / OFF |
| ⑥ Manual recording       | You can manually record by touching the button. If you press it again, manual recording will end.   |                        |          |
| ⑦ Power off              | Shut down the system  |                        |          |
| ⑧ Wi-Fi                  | When you touch the Wi-Fi button, a voice telling you about registration standby mode will sound. If there is no connection for 2 minutes, it will automatically disconnect, and when you touch it again, a voice guidance will sound. |                        |          |



▶ If the product is equipped with a Wi-Fi module



▶ If the product is not equipped with a Wi-Fi module

### LCD Monitor

Change Into Wi-Fi or Cloud Mode

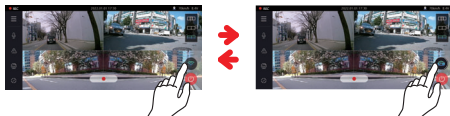

- Hold the Wi-Fi button for 5 seconds to switch between Wi-Fi mode & CLOUD mode.

#### ⑨ Dividing Screen

The screen can be split.



3 screen divisions



2 screen divisions



4 screen divisions



#### TOUCH TEST

If the LCD touch does not work well, perform a touch test. Just drag on the screen as shown below.

\* When you go to the main screen and press the power button three times for over 0.5 seconds, it switches to the touch calibration screen.

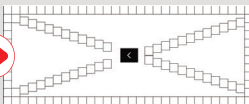
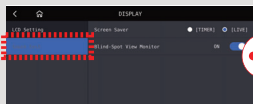

## Real-time video : 4 divisions

When you touch the [Real-time video button] on the main screen, the real-time screen below appears.

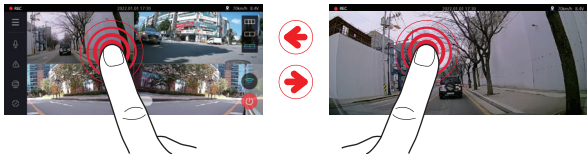

### Real-time video on 4 Channels

You can view real-time video from the front, side, and rear cameras at a glance through the 4-split screen. If you touch the desired video, the video will expand to full screen. When you touch the screen again, it changes to a 4-split screen

Recording Mode

|                  |                            |  |
|------------------|----------------------------|--|
| Normal Recording |                            | <p>The dashcam will turn on as you turn on the vehicle engine. The security light flashes once every 2 seconds during normal recording.</p>  |
|                  | Parking Recording          | <p>Parking mode is activated after 10 seconds from the time of turning off the engine. During Parking mode, the dashcam records at 1 FPS to extend recording time. If motion or impact is detected, the dashcam records at 10 FPS for every 20 second.</p> <p>The security LED light blinks per a second. Parking mode will end if ACC power is connected. (2 wired mode)</p> <p>Parking mode is activated 2 minutes after there is no movement for 10 minutes or the voltage drops by 0.5V to 1.0V. If an impact is detected by the dashcam or the voltage rises above 1.0V, Parking mode switches to Driving mode.</p> |
| Event Recording  | Impact Recording           | <p>Event recording activates if there is an impact or shock detected. The recording LED light flashes continuously during the event recording and saves the file as an event file. After event recording ends, it will automatically change back to normal recording mode.</p>   |
|                  | Motion Detection recording | <p>Under parking mode, the device will record any movement happen within around 3 meters. Security LED will quickly flicker. When no motion is detected, it automatically changes to parking mode.</p> <p>Manual event recording is triggered by the manual record button if no impact has occurred. If you press the manual recording button, the device will identify the moment as an event and categorize the video under the 'manual' folder. It is recorded in 30 FPS and the security LED light will flash.</p>   |

## Play footages

When you touch the [Play] button on the main screen, a real-time screen appears as shown below.

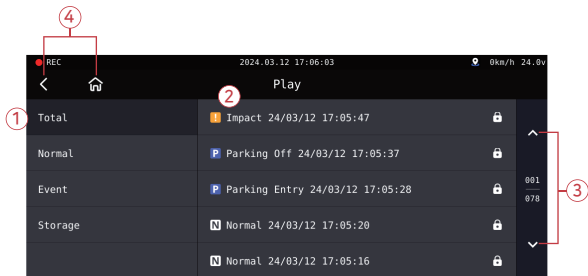

- 
- ① You can sort the **Total/Normal/Event/Storage** list using the buttons above.
  - ② When you touch the video of the desired time zone, the video will play on a screen like the picture on the next page.
  - ③ Press the left or right arrows to advance to the previous or next footage.
  - ④ Press the home button or back button to go to the home screen.
-

## Play footages : Lock function

Add the video you want to save separately to [Lock] in the recorded video list.

- 1 Add directly: When you press the Add Lock button on the playback screen, it will be added to [Lock].

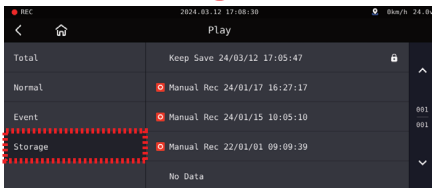
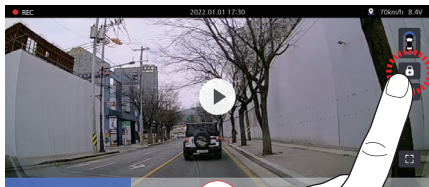

## Play footages : Lock function

- 2 Automatic addition: Manually recorded video on the real-time screen is automatically added to [Lock].

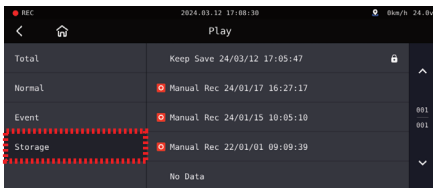
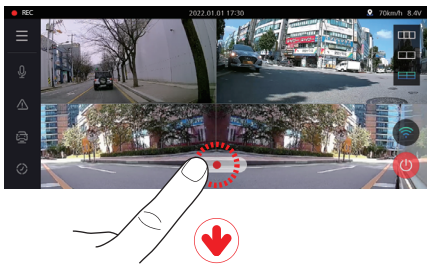

## Play : Playback Screen

Each button on the screen disappears 5 seconds after no touch input, and reappears when the screen is touched.

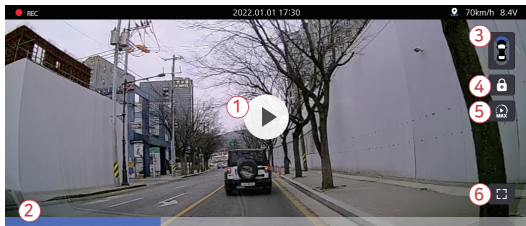

- 
- ① Play/Pause Button (Center)
  - ② It displays the current playback position of the video, and when you touch the desired position, the video will play from that point. When the current video playback ends, the next video in the list will play automatically.
  - ③ Switching between front/rear/left/right camera views.
  - ④ Save the video to the lock storage by pressing
  - ⑤ This is a time-lapse function that allows you to play videos at a fast speed.
  - ⑥ When you touch the back button, it returns to the video list.
-



## Play : Playback Screen -Screen zoom function

If precise verification of a specific part is needed during video playback, you can slide with two fingers to zoom in approximately three times, similar to enlarging with two fingers, to get a closer view

- 1 After playing a video in the playlist, if you touch the empty space excluding the buttons, the buttons will disappear

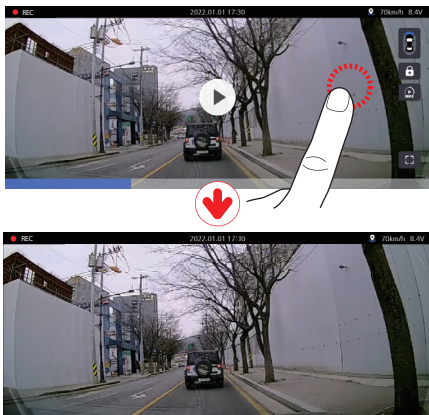

## Play : Playback Screen -Screen zoom function

- 2 If you slide with two fingers as if zooming in on the desired area, the screen will be enlarged at that specific portion.

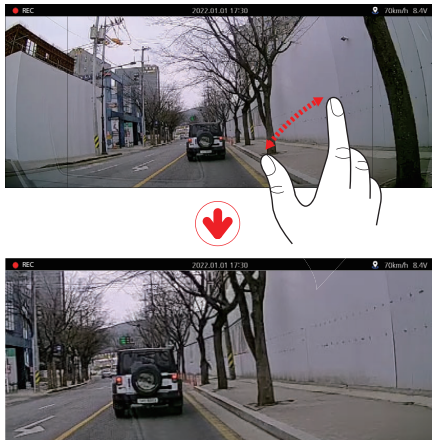



- 3 If you slide as if reducing the screen size and then return to the video list by pressing the back button, the screen size will return to its original state

## Settings

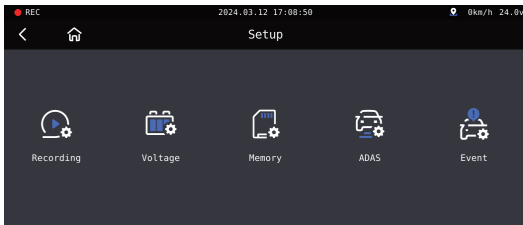
When you touch the [Settings] - [Blackbox Settings] button on the main screen, the following settings menu screen will appear.



The saving of the changed settings is carried out when returning to the main screen

To apply the changed settings, you must return to the main screen (initial screen) using the  home button or  the back button and press 'Yes' in the popup window.

**When changing settings such as front, rear, parking on/off, memory (adjusting ratio, formatting), and standard time zone, the changes will be applied after the system is rebooted.**

## Setup : Recording

When you touch the [Recording] button in the settings screen, a screen appears where you can configure camera and recording setup.

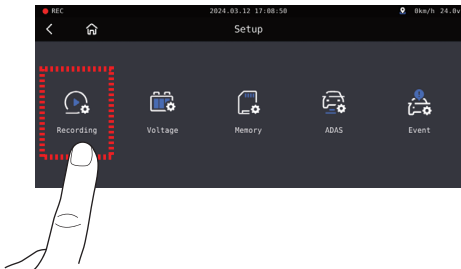

① Front Camera Settings: The screen for configuring resolution, brightness, event (FPS), general, and night vision settings will appear



※ If Night Vision is turned ON, the brightness will increase during night-time

## Setup : Recording

② Rear Camera Settings: The screen for configuring resolution, brightness, event (FPS), general (FPS), and video inversion Setup will appear.

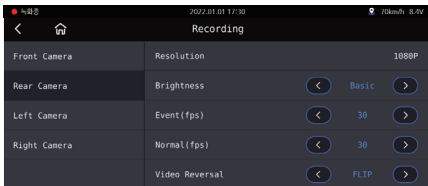

③ Side (Left/Right) Setup: The screen for configuring resolution, brightness, event (FPS), general (FPS), and video inversion Setup will appear.

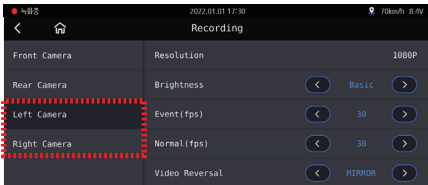

### Cautionary Notes for Camera Setup

The general FPS (frames per second) cannot be set higher than the event FPS value. If you attempt to set it higher, a message similar to the screen will appear when touching the home button or the back button, and the event and general FPS values will become the same.

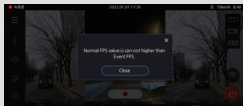

## Setup : Voltage

When you touch the [Voltage] button in the settings screen, a screen will appear where you can configure LBP and automatic shutdown settings.

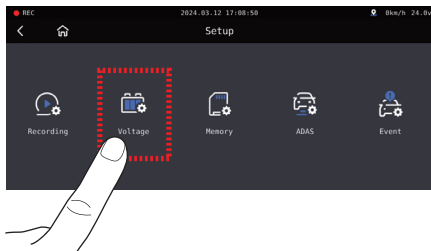

① LBP : You can turn the LBP and winter LBP functions On/Off, choose between 2-wire/3-wire, and set the Power Off voltage

LBP: Intelligent Vehicle Battery Discharge Prevention Function

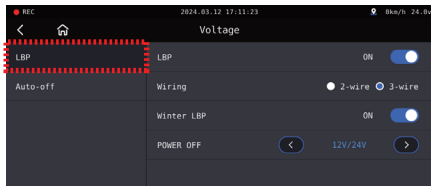

2-wire: When connecting VCC and ACC together. 3-wire: When connecting VCC and ACC separately.

| VOLTAGE  |           |           |           |           |           |
|----------|-----------|-----------|-----------|-----------|-----------|
| PowerOff | 11.3/23.3 | 11.5/23.5 | 11.8/23.8 | 12.0/24.0 | 12.3/24.3 |
|          | 12.5/24.3 | 12.8/24.3 | 13.1/24.3 | 13.4/24.3 |           |

## Setup : Voltage

### ② Auto-Off

#### 2-1) Timer

You can set the equipment to automatically shut down from 1minute to 48 hours after the vehicle's ignition is turned off.

#### 2-2) High-Temperature Cut-off

In parking mode, you can set the device to cut off the power if the external temperature of the dash cam rises.

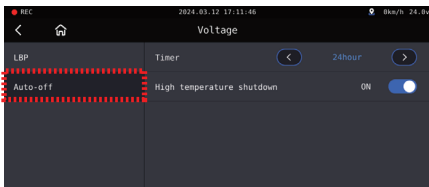

※ Continuous 2-wire cable connection does not support timer and high-temperature cut-off functions

## Setup : Memory

Pressing the memory button allows you to change memory settings and check memory information

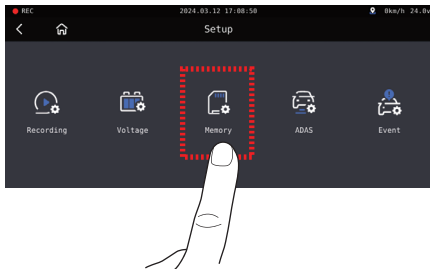

### ① Memory Information

Pressing the memory information button allows you to check memory capacity / recycle count/and usage start date.

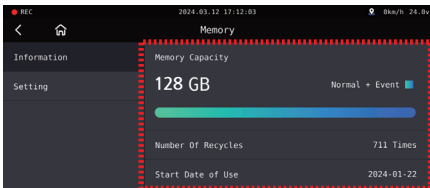



## Setup : Memory

### ② Memory Settings

①-1) You can adjust the memory ratio for event and general recordings.

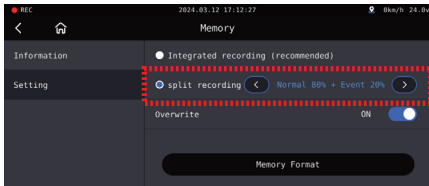

| Integrated Recording (Recommended)                                       | Split Recording  |
|--|--|
| Sequentially stores general recordings and event recordings in all areas | Divides the memory space to separately store general recordings and event recordings |

! If you change this setting and save it, all existing recorded data will be erased

①-2) You can turn ON/OFF the memory overwrite function.

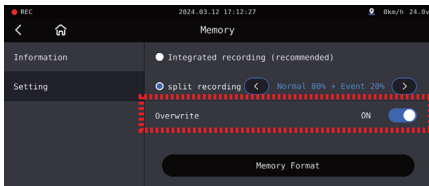

## Setup : Memory

①-3) If you touch the Memory Format button to start SD formatting, the formatting process will proceed. After completion, the system will reboot

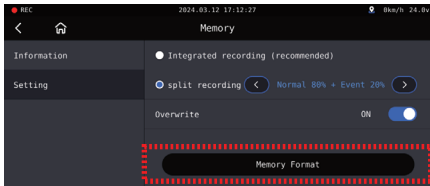

## Setup : ADAS

If you touch the ADAS button, you can configure and fine-tune ADAS function settings.

You can only configure ADAS settings after connecting to GPS.

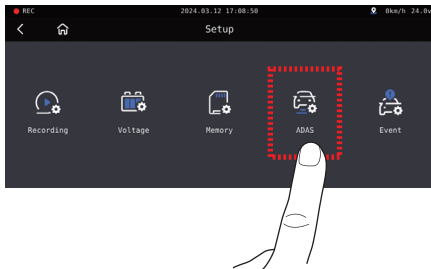

① ADAS Settings: Through the ADAS function ON/OFF button, you can turn the entire function ON/OFF. While ADAS is ON, you can individually turn ON/OFF FVSA, FCWS, LDWS functions.

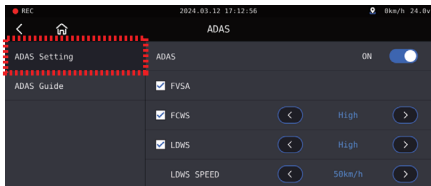

## Setup : ADAS

- 1-1) Advanced Settings: In ADAS detailed settings, you can set the lane departure detection sensitivity and collision detection sensitivity to low, basic, high. You can also configure the lane departure detection speed to 50km/h, 60km/h, 70km/h, triggering an alert when the vehicle speed exceeds the set value.

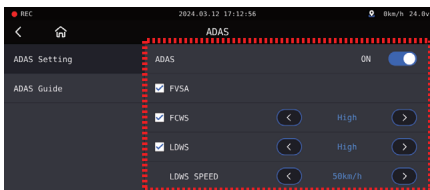

## ▶ ADAS Functions

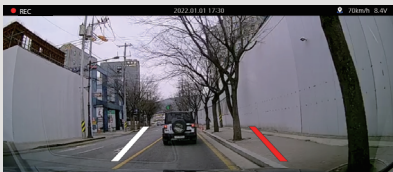

## ① Lane Departure Warning System(LDWS)

Function that notifies when the vehicle departs from its lane

As shown in the picture, when a lane is detected during vehicle operation, it is indicated by a white line. If the vehicle deviates from the lane while driving, it is indicated by a red line and an alarm will sound. Lane departure detection alerts only function when the vehicle speed exceeds the set speed.

## ▶ ADAS Functions



## ② Front Vehicle Start Alarm(FVSA)

A feature that informs the driver when the front car has started to move, as shown in the illustration. When the distance between the stopped vehicle and the front car is more than 2 meters, an alert sound is accompanied by the front car departure icon appearing on the LCD screen



## ③ Forward Collision Warning System(FCWS)

A feature that notifies when there is a risk of a rear-end collision. When the distance between the front car is short and the speed of the vehicle is high, or when the distance to the front car rapidly decreases within a short period, a collision alert icon will be displayed on the LCD screen accompanied by an alert sound

The lane detection point, front car departure, and collision alert icons can only be viewed on the LCD screen when the current state is real-time video

- ▶ Installing the dash cam in the center improves the recognition of ADAS functions
- ▶ The recognition rate of ADAS may be compromised during nighttime

## Setup : ADAS

- ① Guide Screen: The guide lines are visible, and pressing the full button switches to the full screen. Vertical adjustment of the red horizontal lines is possible

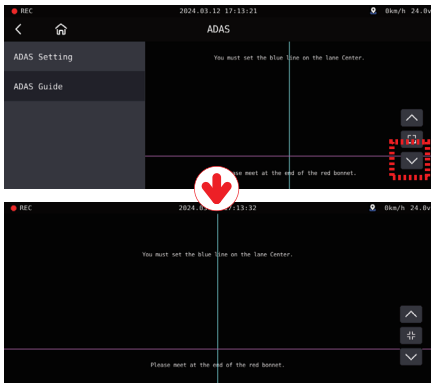

## Setup : Event

Pressing the Event button allows you to change the settings for Event/Parking/Impact

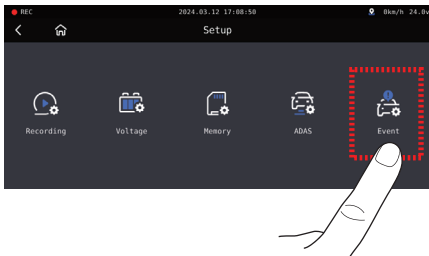

Touching the Event button on the settings screen allows you to configure recording time (time after the event), Touching the Event button on the settings screen allows you to configure recording time(time after the event), buzzer, parking, motion detection ,impact and sensitivity.

The parking, motion detection, impact and sensitivity functions can be set to on/off by touch, and recording time can be adjusted using the arrow keys.

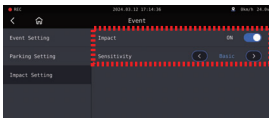
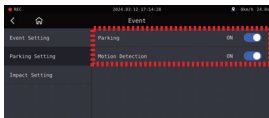
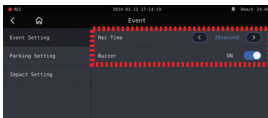



## Setup : Systems

Pressing the System button allows you to change system settings and check version information.

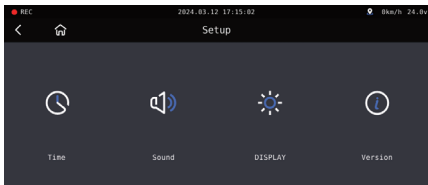
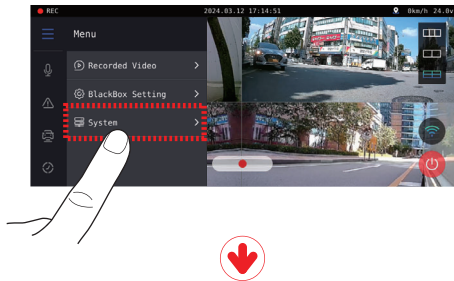

## Setup : Systems

- ① Time: Touching the Time button allows you to set the date and time, enable Auto reboot, and configure the standard time zone.

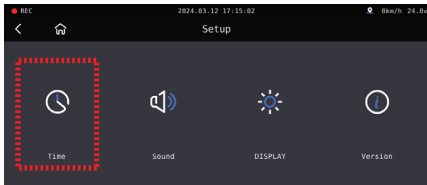

- 1-1) Date/Time: Touching the Date/Time button allows you to configure date and time settings. You can manipulate them by touching the arrows.



## Setup : Systems

1-2) Auto Reboot: Touching the Auto Reboot button allows you to toggle the reboot setting ON/OFF and configure the reboot time.

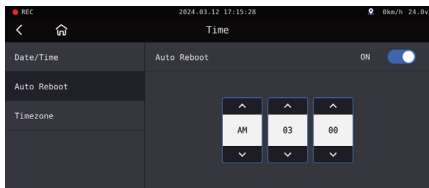
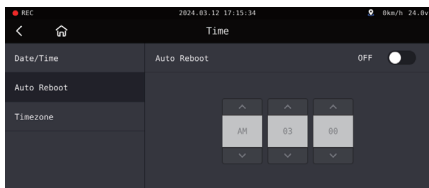

## Setup : Systems

1-3) Time Zone: You can check the time zone for each country and set the time zone accordingly.



② Sound: Touching the Sound button allows you to configure voice guidance and audio recording settings

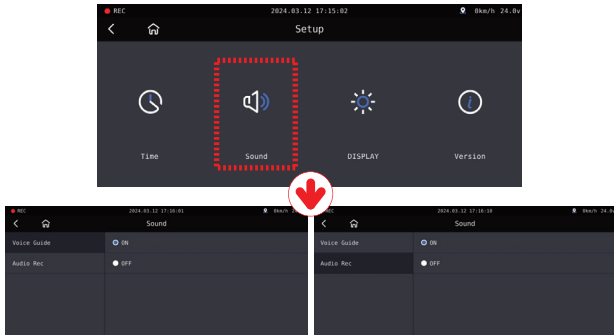

## Setup : Systems

③ DISPLAY: You can configure DISPLAY settings and perform a touch test

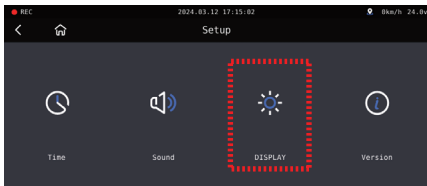

3-1) DISPLAY Settings: If there is no input for 30 seconds, the page will change to a screen where you can choose between 'Screensaver' [Clock] and 'LIVE VIDEO' settings.

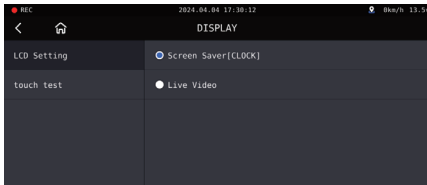

- Screensaver [Clock], [LIVE VIDEO]

When there is no touch input for 30 seconds during the process of setting up the functions, the screen saver (clock) or Live video will switch.

## Setup : Systems

3-2) Touch Calibration: If the LCD touch is not working well, you can perform a touch test. Follow the instructions on the screen and touch the center of the crosshair in order

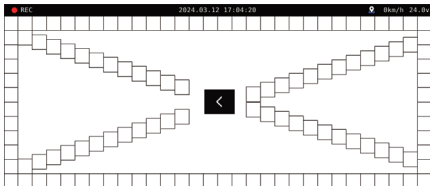
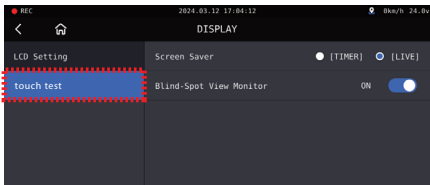

Voice Guidance

| CONTENTS                             | VOICE GUIDANCE   |
|--------------------------------------|--|
| Normal recording                     | Start recording  |
| System Off                           | Shut down the system   |
| Overwriting                          | Recording does not have enough available.<br>Please check overwriting setting. |
| GPS connection                       | GPS connected.   |
| Abnormal recording                   | Video is not being entered.  |
| Enable registration                  | Stand-by mode for the registration.  |
| Disable registration                 | Stand-by mode for the registration is released.                                |
| Not supported Wi-Fi module           | This Wi-Fi module is not supported   |
| No Wi-Fi Dongle                      | No Wi-Fi Dongle  |
| Complete the smartphone registration | Complete the registration  |
| Already registered smartphone        | Already registered smartphone  |
| Connect the Wi-Fi                    | Users connected.   |
| Disconnect the Wi-Fi                 | User access disabled.  |
| Connect the playback mode            | User's searching starts so, recording is paused.                               |
| Disconnect the playback mode         | Restart recording.   |

| CONTENTS                                | VOICE GUIDANCE   |
|---|--|
| Change the Smartphone setting           | Setting changed and reboot   |
| Change parking mode to normal recording | Driving mode to start recording. Safe driving  |
| Format the Micro SD memory card         | On- formatting the memory card. Please wait  |
| No Mirco SD memory card                 | No Memory card   |
| Micro SD memory card damage             | Memory card is damaged and can not be recorded   |
| Micro SD memory file system recover     | Reboot because of the damaged memory card.<br>Please replace the memory card if this continues |
| Update the firmware                     | On installing the program. Do not turn off the power   |
| Fail to firmware update                 | Program file is corrupt and can not be installed.  |
| Event recording alarm                   | Impact event has occurred during parking   |
| LBP ON                                  | Shut down the system to protect the battery of car   |
| LBP OFF                                 | Restart the system to protect the battery of car   |



- 1** Remove memory card after the device turn off

---

- 2** Insert the memory card into the memory reader and connect it to the USB port of PC

---

- 3** Select removable disk in explorer folder.
  - Folders in the removable disk are displayed as shown in the following page
  - "Event" folder is created if the event save capacity is setting over 10%.

 **Do not randomly delete or format files in memory card.**  
Backup the important file to PC

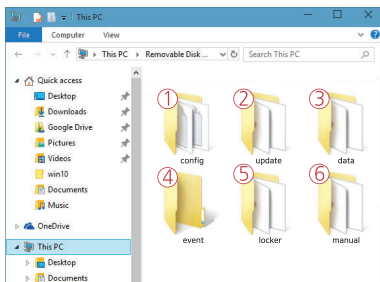

Estimated Recording Time Based on Memory Card Capacity (Default: Front/Rear 30FPS)  
 128GB(10h 35min), 256GB(21h 10min)

|  |  |
|--|--|
| <p>① Config<br/>         (Product System Management Folder)</p>    | <p>Log.txt: Saves the operational status of the device as a log file.<br/>         Version.ini: Stores the version information of the device</p>                   |
| <p>② Update<br/>         (Device Firmware Update Folder)</p>       | <p>To update the firmware, open this folder and drag the update data. It will update automatically</p>   |
| <p>③ Data<br/>         (Continuous Recording Folder)</p>           | <p>Stores continuous recording data. The number of files may vary depending on the memory card capacity and is created in advance to ensure space availability</p> |
| <p>④ Event<br/>         (Event Recording Folder)</p>               | <p>Stores event (impact, movement) data. 'Parking' events are stored in the regular (Data) folder</p>  |
| <p>⑤ Locker<br/>         (Added to Continuous/Event Recording)</p> | <p>For continuous/event recording videos, data from videos where the 'Locker' button was pressed is copied and stored in this folder.</p>                          |
| <p>⑥ Manual<br/>         (Manual Recording Data)</p>               | <p>Videos recorded manually from the real-time video screen are stored in this folder</p>  |

## Install the PC Viewer (WINDOW)



The recommended specifications for playing Full HD videos on a PC are **a CPU i5 3.0GHz or higher and 4GB** or more of memory. On PC with lower specifications, video playback may not work, or there may be interruptions

- 1 If it's the first time using a Micro SD card or if the Micro SD card has been formatted, the viewer is not installed.  
-----
- 2 Please insert the Micro SD memory into the product and turn on the power of the product  
-----
- 3 The recording start time may vary depending on the capacity. Please do not turn off the power during the operation of creating the data file system (all LEDs blinking, and when recording starts after normal booting, the REC LED is lit) for about 3 to 5 minutes  
-----
- 4 After removing the Micro SD memory, insert it into your PC.

- 5 Run the Viewer.exe installation file stored on the Micro SD memory as shown in the picture

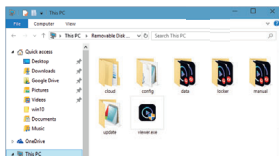

- 6 In the User Account Control Pop-up, click the 'Yes' button.

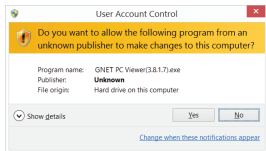

- 7 On the installation screen, click the 'Next' and 'Install' buttons in order.

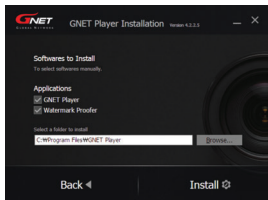

- 8 If the network is connected, a window for checking the latest version will appear as shown in the picture. If the connection is not established, the window will not appear, and the dedicated viewer for the product will be launched



- 9 Press 'Run Viewer,' and the viewer will be launched

- 10 Once the installation is complete, the dedicated viewer program for the product will automatically run, and an  icon will be created on the desktop



- 11 Open File - Click the 'Open File' button  in the viewer, and a folder browsing window will appear as shown in the picture. Please select the removable disk and press the 'OK' button.

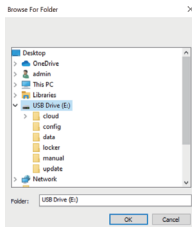



① Upper Button

② Google Map  
It can be used when GPS are connected

③ Playlists and Information display

④ GPS reception window  
Available when GPS is connected

⑤ Video Control Pop-up

|  |                       |
|--|-----------------------|
|  | Thumbnail             |
|  | Draw a lane           |
|  | View a screen         |
|  | Split View            |
|  | PIP View              |
|  | Toggle (change) Color |

⑥ G-Sensor (acceleration) Graph

⑦ Speedometer  
It can be used only when an external GPS is connected

⑧ Play a recorded video

|  |                      |
|--|----------------------|
|  | Forward play         |
|  | Pause                |
|  | Repeat event video   |
|  | Previous, Next Event |
|  | Play one frame       |

⑨ Adjust playback speed

⑩ Sound control



## How to install PC viewer (MAC OS)

Download the GNET VIEWER from APP STORE

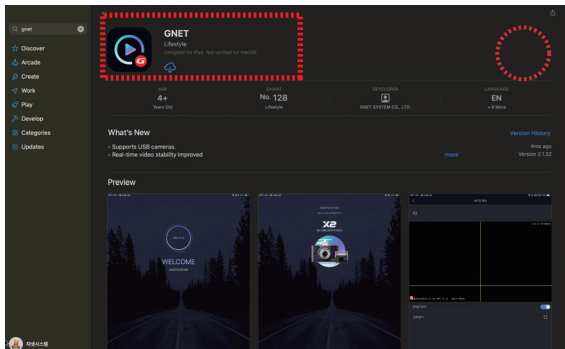



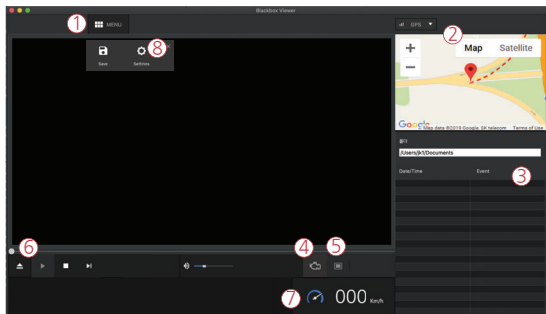

## ① Menu Button



## ② Google Map

It can be used when GPS are connected

## ③ Playlists and Information Display

## ④ Activate if dash cam is connected thru OBD

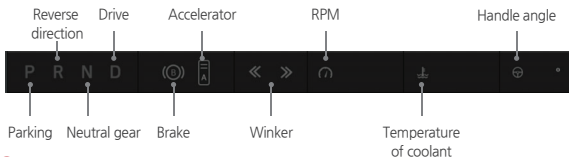

## ⑤ Screen setting

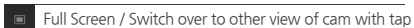

- ⑥
- ▶ Play
  - Pause
  - ▶ Previous, Next event

⑦ Speedometer It can be used only when an external GPS is connected

⑧ Dash cam setting (System / Event / User / Version)

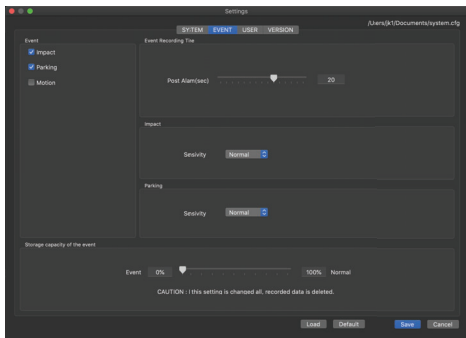

## Precaution before connecting the Smartphone

Available for Android and Apple IOS. Search “GNET” on Google play and App Store.  
Simply scan and access the QR code below.

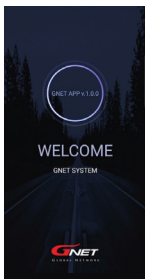

- Spec of Smartphone can interfere and delay real time video and video playback.
- DO NOT operate the device or adjust APP settings while driving.  
Please always safely pull over when interacting with GNET product.

## How to connect an Android Smartphone

- 1 Install the GNET application on the Smartphone.

\* GNET application is not available while cloud mode is on.



- 2 Press the Wi-Fi button on the dash camera to enter standby mode with the voice message. (last 2 minutes)

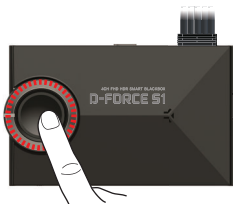

- 3 Touch the "+" to search for your device - use the left and right arrows scroll. Once your device has been located select the "Connect" button.

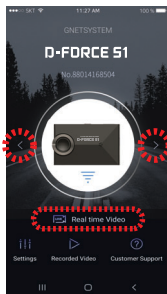
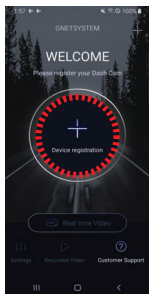

- 4 The registration of the dash camera is completed.

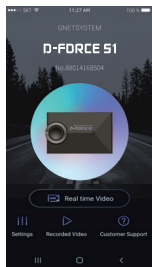

### Failure of Connection

If the connection fails due to a weak Wi-Fi signal, please carefully unplug and immediately re-insert the Wi-Fi dongle back into the camera. Proceed to try the connection again by pressing the Wi-Fi Button to enter standby mode.

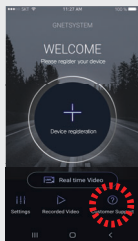

## How to connect an iOS Smartphone

- 1 Install the GNET application on the Smartphone.

\* GNET application is not available while cloud mode is on.



- 2 Press the Wi-Fi button on the dash camera to enter standby mode with the voice message. (last 2 minutes)

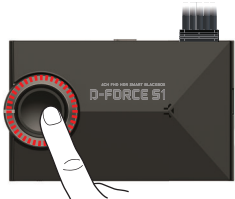

- 3 Turn on the Wi-Fi

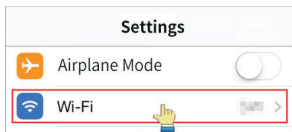

- 4 Connect to the Wi-Fi network, which start with GNET\_BB\_

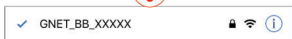

- 5 Enter the password [qwertyuiop]

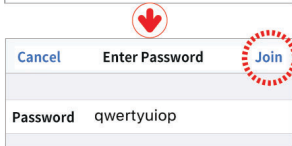

6 The registration of the dash camera is completed.

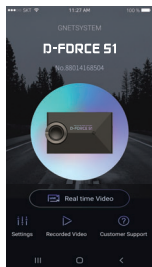

### Failure of Connection

If the connection fails due to a weak Wi-Fi signal, please carefully unplug and immediately re-insert the Wi-Fi dongle back into the camera. Proceed to try the connection again by pressing the Wi-Fi Button to enter standby mode.

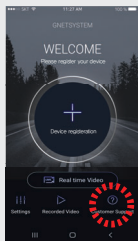

## How to connect with LCD monitor

- 1 Touch the Wi-Fi icon on the LCD monitor



- 2 Standby mode with the voice message. (last 2 minutes)

 ▶ Wi-Fi module has been installed

 ▶ Wi-Fi module has been NOT installed



## Description of APP Main screen

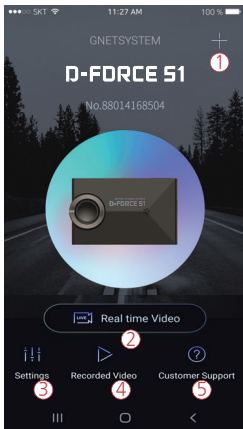

- ① This function allows you to connect other dash cams or delete the registered devices.  
※ Supported only on Android
- ② Real-Time Video  
Select this button to view a live video feed from the dash cam.
- ③ You can easily toggle camera settings with smartphone. When finished, select the "SAVE" button to reboot the system.
- ④ View previously recorded video from the camera SD card. Video can be downloaded directly onto the smartphone.
- ⑤ If you need product support, select this button to go to the Customer Support Center.

## Description of App screen for a recorded video

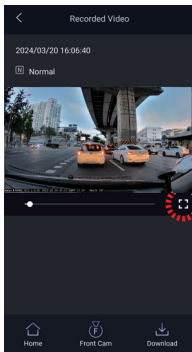

Vertical and horizontal modes are provided. Allowing you to view the images in a wide screen depending on the situation.



## WARRANTY CARD

|                             |   |                        |            |
|-----------------------------|---|------------------------|------------|
| <b>Product</b>              | GNET Dash cam   | <b>Model</b>           | D-FORCE S1 |
| <b>Serial Number</b>        |   | <b>Purchasing Date</b> |            |
| <b>Consumer Information</b> | <b>Name</b>   |                        | <b>Tel</b> |
|                             | <b>Address</b>  |                        |            |
| <b>Seller / Vendor</b>      |   | <b>Tel</b>             |            |
| <b>Warranty Period</b>      | Dash Camera : 2 Years<br>LCD Monitor : 1 Year<br>Micro SD card : 6 months |                        |            |

\* If you require product repair, service and/or support, please contact your local seller or send us an email: [info@gnetsystem.com](mailto:info@gnetsystem.com)

MOTOR  GUARDIANCAM

[www.motorgc.com](http://www.motorgc.com)  
2200 Estes Ave. 2F  
Elk Grove Village, IL 60007  
[sales@motorgc.com](mailto:sales@motorgc.com)  
(847) 296-4279

